

SIATA SFE MANUAL



INDEX

1-DECLARATION OF CONFORMITY	3
2-General Instructions	4
3-General Features	5
4-Functions	6
4.1 Description of the control panel	6
4.2 Display	7
4.2.1 Display in Service	7
4.2.2 Display in Regeneration	8
4.2.3 Display during battery operation	8
4.3 General Information before programming	9
4.4 Manual Regeneration	9
4.5 Microswitch search	10
4.6 Salt Recharge	10
4.7 Statistics Menu	10
4.8 Reset eeprom	11
4.9 Power Failure	12
5- Programming	13
5.1 Basic Programming	13
5.2 Advanced Programming	14
5.3 Regeneration Mode displays	17
Error Message	18
Hardware Reset	18
7- Installation	19
7.1 Installation with V132/230	19
7.2 Installation with V250	21
Controller spare parts	23
Connection diagrams	29

1 - DECLARATION OF CONFORMITY

The products of series

Timer S F E

Comply with the following Directives:

2006/42/EC: Machinery Directive

2006/95/EC: Low Voltage Directive

2004/108/EC: Electromagnetic Compatibility

Meet the following technical standards:

- EN 61010-1: Safety provisions for electrical measurement, control and laboratory equipment - Part 1: general provisions.
- EN 61000-6-1: Electromagnetic compatibility. Part 6-1: Generic standards - Immunity for residential, commercial and light industrial environments.
- EN 61000-6-2: Electromagnetic compatibility. Part 6-2: Generic standards – Immunity for industrial environments.
- EN 61000-6-3: Electromagnetic compatibility. Part 6-3: Generic standards - Emission for residential, commercial and light industrial environments.
- EN 61000-6-4: Electromagnetic compatibility. Part 6-4: Generic standards – Emission for industrial environments.
- EN 55014-1: Electromagnetic compatibility - Provisions for household appliances, electrical tools and like equipment. Part 1: emissions.
- EN 55014-2: Electromagnetic compatibility - Requirements for household appliances, electrical tools and like equipment. Part 2: Immunity - Family product standard.

2 - GENERAL INSTRUCTION



Read this user and maintenance manual carefully before using the device.



The controller must be installed by qualified personnel; the installation procedures must be carried out with equipment switched off.

Package and storage

The equipment is packaged in a formed polystyrene frame and contained in a cardboard box. No special procedures are required for unpacking.

The equipment should be stored in places having the following features:

- temperature in the range -10°C to $+60^{\circ}\text{C}$;
- relative humidity in the range 30% to 95%.

Installation

The equipment should be installed and commissioned by specialised personnel in compliance with the regulations in force in the country of use.

The equipment should be installed in a dry place, not directly exposed to the sun, with temperatures between -10°C and $+60^{\circ}\text{C}$.

Do not power the equipment with a voltage value other than that indicated in this user and maintenance manual.

Cleaning

The equipment should be cleaned with a dry cloth.

In the case of hard dirt, disconnect the equipment from the power supply network and use a damp cloth.

At the end of the cleaning, restore the electrical connection.

3 - GENERAL FEATURES

The SFE controller allows the management of softening and filtering systems. The controller is based on two electronic boards for TC & metered versions SFE is available with 2 different electronic boards: **standard 7930-23** or **chlorine cell control 7930-24**.



7930-23 – The standard board allows to program a dry contact relay



7930-24 – This board allows to drive a chlorine producer

Based on the system configuration, the installer can select the controller settings via software. To this end, refer to paragraph 5, dedicated to programming.

Technical features

Power supply data:

Transformer model 95-STD1	Primary: 230 Vac Mains frequency: 50 or 60 Hz \pm 2 % Secondary: 11.5 Vac; 600 mA
Power output for Chlorine producer*	6 Vdc \pm 10 %; 800 mA
Dry contact relay data**	Max input current: Input voltage range:
IP protection rate	IP30

*Only for board 7930-24

** Only for board 7930-23

4 - OPERATION

4.1 Control panel description

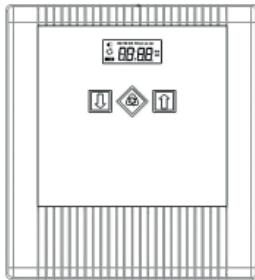

Buttons description



Key
Down arrow



Regeneration



Up arrow

Description

It is used to edit the displayed value during a programming step. Press it together with the arrow up key for 5 seconds to open the advanced settings menu.

Press and release to access the basic settings menu. Press for 5 seconds to manually start the regeneration. While programming, it allows switching to the next parameter.

It is used to edit the displayed value during a programming step. Press it together with the arrow down key for 5 seconds to open the advanced settings menu.

4.2 Display



Key

1. Service status icon;
2. Weekdays icon;
3. Time display mode icon;
4. Programming parameters/regeneration status/time digit;
5. Power supply status icon (if it is enabled it indicates a lack of mains supply and storage of the programming data to the memory);
6. Regeneration in progress icon.

The LCD display used on the controller shows a series of operation-related data. The data displayed are:

4.2.1 Display during service

When the module is in operation, the display shows the following information:

- Time: xx:xx with flashing ":".
- Weekday, if the day of the week is flashing it means that the regeneration is enabled for that day.
- Service icon 
- Residual volume and time are displayed alternately, if volume regeneration is enabled.



In service

4.2.2 Display during regeneration

When the module is in regeneration, the display shows the following information:

- During the transition phases $nC-$, where n is the number of the regeneration cycle phase, a turning bar is display to mean that a transition is occurring from a regeneration phase to the next one.



Transition to phase 1

- During the stopping phases nCx , where n is the number of the regeneration cycle phase and xx are the residual minutes before switching to the next phase.





Phase in progress and time remaining before passing to the next step

- Regeneration in progress icon, steady on. 

4.2.3 Display during battery operation

When the module is battery supplied, the display shows the following information:

- Time: $xx:xx$ with flashing “:”.
- Weekday, if the day of the week is flashing it means that the regeneration is enabled for that day.
- Service icon 
- Residual volume and time are displayed alternately, if volume regeneration is enabled.
- The battery icon is displayed 

In battery-operated mode, the regeneration is not carried out and the parameters cannot be edited.



Battery-operated status

4.3 General information before programming

The SFE controller allows to manage your installation by a time clock control or by a volumetric control. The controller will automatically initiate regenerations cycles based upon the programmed regeneration mode and the programmed parameters.





The SFE controller offers the possibility to manually start regeneration simply by pressing the regeneration button, as well as initiate a regeneration from an external signal.

The controller is able to receive an external signal for regeneration inhibition, that will block any regeneration start as long as the inhibit signal is received by the controller.

The SFE controller can manage a chlorine production cell that will be activated during the brine draw cycle of the regeneration.

Whenever a regeneration has started, the regeneration can be cancelled by pressing  button for 5 seconds. The controller will then place the valve back to service position.

4.4 Manual regeneration

To initiate a manual regeneration, press and hold the  button for five seconds. The SFE controller allows choosing whether to start the regeneration immediately or delayed at the programmed time. Here under are showed the two displayed options, use the buttons   to scroll and press  to confirm.



Immediate manual regeneration



Delayed manual regeneration

When Delayed manual regeneration is chosen current day of the week and service icon are going to blink until regeneration starts



Day of the week and service icon blink to confirm Delayed Manual Regeneration

4.5 Microswitch search

When powering the module may sometimes display **F1-** or **F2-** where the number indicates if we are carrying out the first or the second microswitch search attempt, a turning bar is also shown to indicate that the motor is on. If both searches fail, the message **FR01** is displayed.

4.6 Salt recharge

The controller has a counter that is decreased by one at each regeneration. When the counter reaches 0, a salt alarm is generated. To recharge the counter to the initial value of the parameter **SA**, press and hold **↓** when the module is in service, “**SAL**” will flash on the display for 5 seconds and the counter will be reset to the value setup.

4.7 Statistics menu

The Statistics menu displays some historical data of the module. To open the Statistics menu, press and hold **↑** for 5 seconds.

The following data are displayed:

Data	Description
Xxxx	Number of regenerations carried out
SAxx	Number of residual regenerations before the salt alarm is generated.
FFxx	Number of days elapsed since the last regeneration.
Lxxxxxx	Overall volume treated (in litres).
Xx:xx	Day and time of the last regeneration carried out, the regeneration icon is on.
Xx:xx	Day and time of the second last regeneration carried out, the service icon is on.
Xx:xx	Day and time of the third last regeneration carried out service and regeneration icons are on simultaneously.
End	End of the statistics.
189x	Software release and revision.

The treated volume is displayed on a running string so as to allow reading a number greater than 9999.





Press  to switch parameters .

The date and time information for the last regenerations carried out are only available if regenerations have been carried out.

While the statistics are displayed, the regeneration icon is on, if not otherwise indicated.

4.8 Reset eeprom

To reset the eeprom to the default values, proceed as follows. In the service condition (regeneration cycle not running and clock displayed):

- To open the Statistics menu, press and hold  for 5 seconds.
- Press and release the 
- Press and release the 
- Press and release the 
- Press and hold the  for about 5 seconds

The display shows "rSt" for a few seconds; this means that the eeprom has been reset to the default values.

NOTE: this procedure does not reset statistical data.

4.9 Power failure











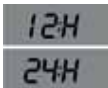

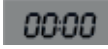

The following conditions may occur in the event of a power failure:

- *The power failure occurs during the standby phase, during a parameter reset phase, during the statistics analysis phase.* In all these cases, the module returns to stand by and displays the clock with the battery on icon, meaning a power failure. If the power failure occurs during a parameter reset, the reset is closed without saving any changes made and at the end of the power failure it will be necessary to go to parameter reset again and make the changes.
- *The power failure occurs during a phase transition or a microswitch search.* In this case, the module still displays the current phase, the battery icon is turned on to indicate the blackout, the turning bar is blocked to indicate that the motor has stopped. At the end of the power failure, the motor restarts to complete the movement.
- *The power failure occurs during a phase of the regeneration cycle.* In this case, the module still displays the current phase, the battery icon is turned on to indicate the power failure, the time count down is stopped. At the end of the power failure, the stoppage time count is restarted and the process goes to the next step.
- *The power failure occurs during an alarm.* In this case, the module still displays the alarm and the battery icon is turned on to indicate the power failure. At the end of the power failure, the module remains in alarm status.

5 - PROGRAMMING

5.1 Basic programming

The most common operating parameters are set in the basic menu. To access the basic menu, press and release the  button. The basic menu contains the following parameters:

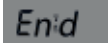















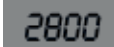

DATA	DESCRIPTION	DEFAULT	MIN - MAX
	Hour format setting as 12 or 24 hours. Press  or  to edit this parameter.	24H	12H - 24H
	Current time. The current time is displayed flashing, together with the day of the week, fixed. Press  or  to edit.	00:00	00:00 23:59
	Day of week. The current day is displayed flashing, together with the current time, fixed. Press  or  to edit.	Mo	N.A.
	Days enabled for regeneration. The display shows "dx y" where x is the day of the week (1-7) and y shows whether the selected day is enabled for regeneration "1" or not, "0". For every enabled day, the top of the display shows the relevant flashing icon. Press  to edit the setting of the selected day (x), press  to enable or disable the selected day (y).	All enabled	N.A.
	Regeneration time. Regeneration start time when a delayed time or cubic metre start is enabled. Press  or  to edit.	2:00	00:00 23:59
	End of the programming.	N.A.	N.A.













Press  to switch parameters.

While the parameters are being edited, the regeneration icon is on and flashing.

5.2 Advanced programming

The module operating parameters are set in the advanced menu. Press  and  at the same time for 5 seconds to open this menu.

DATA	DESCRIPTION	DEFAULT	MIN - MAX
	Regeneration start mode: 0 - Regeneration start at the time set during the enabled days. 1 - Regeneration start at the time set after the volume treatment in the enabled days. 2 - Immediate start at the end of the volume treatment in the enabled days. 3 - Start at intervals. Regeneration starts every 1-2-3-4-8-12 hours. Regeneration starts when the hour strikes, so if regeneration is enabled every two hours, it will be carried out at 0:00, 2:00, 4:00 and so on. NOTE: the first regeneration is carried out at the time set in the basic menu. This function is available during the enabled days. Press  or  to edit.	0	0-3
	Interval time between regenerations. Press  or  to edit. This parameter is displayed after the start up mode only if an interval start has been selected (SH-03).	1	1-12
	Prescale of the volumetric meter. Press  or  to edit. The parameter is composed of the integer part and of the decimal part, separated by the decimal point. This parameter is displayed after the start up mode only if a volume start has been selected (SH-01 or SH-02).	14.0	00 - 99.9
	Volume to be treated (expressed in litres) before starting the regeneration. Press  or  to edit. Thousands and hundreds are modified first, once they are properly set, press  to switch to the tenths and units setting. This parameter is displayed after the prescaler only if a volume start has been selected (SH-01 or SH-02). NOTE: See note 2 to calculate the volume of treatable water between two subsequent regenerations.	28000	1000 - 9999
	Duration of the first regeneration cycle stop (minutes). Press  or  to edit. If the parameter is set to off, the stop will be skipped and the system will directly go to the next stop.	5	0f-99
	Duration of the second regeneration cycle stop (minutes). Press  or  to edit. If the parameter is set to off, the stop will be skipped and the system will directly go to the next stop.	30	0f-99

DATA	DESCRIPTION	DEFAULT	MIN - MAX
◊ 3000	Duration of the third regeneration cycle stop (minutes). Press  or  to edit. If the parameter is set to off, the stop will be skipped and the system will directly go to the next stop.	5	0f-99
◊ 4000	Duration of the fourth regeneration cycle stop (minutes). Press  or  to edit. If the parameter is set to off, the stop will be skipped and the system will directly go to the next stop.	5	0f-99
◊ 5A00	Number of regenerations before a salt alarm is generated. Press  or  to edit. NOTE: See note 1 to calculate the number of regenerations before a salt alarm is generated.	10	00-99
◊ A00	Days of interval for the mandatory regeneration. Press  or  to edit. If this parameter is set to 0f, the function is disabled. NOTE: This type of regeneration is carried out at the regeneration time even on non enabled days.	14	0f-14
◊ FR00	Frequency of the mains 50 or 60 Hz. Press  or  to edit.	50	50-60
◊ FC01	Duration of the cycle end pulse, this parameter can take values from 1 to 99 minutes. Press  or  to edit .(only with 7930-23 board)	FC01	01-99
◊ FCCL	Chlorine driver activated (only with 7930-24 board)	FCCL	N.A.
◊ Ud IF ◊ U IMM	UdIF → Volume not restored UIMM → Volume restored Confirm with  . The volume remaining will be kept in memory or restored to the programmed value, after exiting the programming. (SH 1 or SH 2)	UdIF	N.A.
End	End of the programming	N.A.	N.A.

Press  to switch parameters.

While the parameters are being edited, the regeneration icon is on and flashing.

Note 1: calculation of number of regenerations before a salt alarm is generated.

The following formula is used to calculate the number of regenerations before a salt alarm is generated:
 $SA = (M.xxx) * 1000$

$$SA = \frac{(M.xxx) * 1000}{(L.xxx) * (G.xxx)}$$

where:

M.xxx: amount (in kg) of salt found in the brine tank;

L.xxx: volume of resin, expressed in litres (l);

G.xxx: amount of salt (in grams) required to regenerate 1 litre of resin, (g/l).

The result of the formula gives the number of regenerations before generating a salt alarm and must be typed, rounded down to the closest integer (for example 15.4 must be rounded to 15), in the advanced menu.

Note 2: calculation of the volume of treatable water between two regenerations.

The following formula is used to calculate the volume of treatable water (in litres) between two subsequent regenerations:

$$V_{\text{treatable water}} = \frac{(L.xxx) * (C.xx) * 1000}{(d.xxx - do.xx)}$$

where:

d.xxx: incoming water hardness, in French degrees (°f);

do.xx: desired outgoing water hardness, in French degrees (°f);

C:xx: exchange capacity of the regenerating resin used (expressed in °f x m3/l or in grams of CaCO3);









L.xxx: volume of resin, expressed in litres (l).

The result of the formula gives the volume of treatable water (in litres) between two regenerations and must be typed, rounded down to the closest integer (for example 34.6 litres must be rounded to 34 litres), in the advanced menu.





Note that the desired outgoing water hardness value must be compatible with the provisions of the regulations in force where the controller is used.

5.3 Programmable Regeneration Modes

 	 	 	 
SH 0	SH 1	SH 2	SH 3
◊	◊	◊	◊
1C05	F 140	F 140	5-01
◊	◊	◊	◊
2C30	2800	2800	1C05
◊	◊	◊	◊
3C05	2800	2800	2C30
◊	◊	◊	◊
4C05	1C05	1C05	3C05
◊	◊	◊	◊
5A 10	2C30	2C30	4C05
◊	◊	◊	◊
A 04	3C05	3C05	5A 10
◊	◊	◊	◊
Fr 50	4C05	4C05	A 04
◊	◊	◊	◊
FCCL	5A 10	5A 10	Fr 50
◊	◊	◊	◊
End	A 04	A 04	FCCL
◊	◊	◊	◊
	Fr 50	Fr 50	End
	◊	◊	
	FCCL	FCCL	
	◊	◊	
	End	End	

ERROR MESSAGES

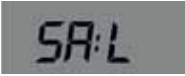
The following error messages may be displayed during operation:

	Salt alarm , the brine tank is empty. Press any key to acknowledge this alarm and reset the salt alarm counter to the programmed value. No regenerations are carried out during the salt alarm.
	Microswitch alarm . The module cannot find the service position. No regenerations are carried out during the microswitch alarm.

RESET HARDWARE

The SFE controller is fitted with a hardware reset button located on the board itself close to the display and not directly reachable by the user.

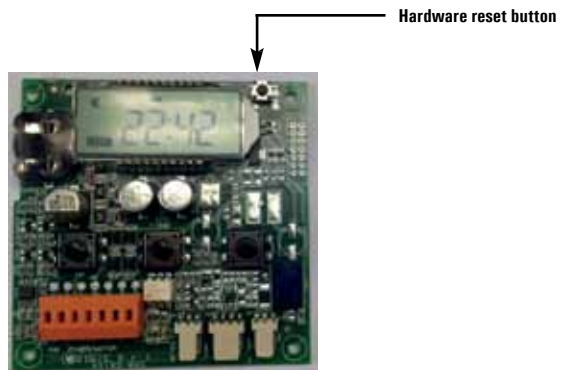

Button to reset the SFE board

After a hardware reset, the time on the display flashes until any button is pressed.

7 - INSTALLATION

The SFE controller may be installed on the following of SIATA valves:
V132, V230, V250 (with the accessory 5191-P).

NOTE: a whole series of accessories is available for installation on the following valves: V240, V260, V360.

7.1 Installation with V132/V230 Valves

No additional accessories are required to fix the controller to the valve.

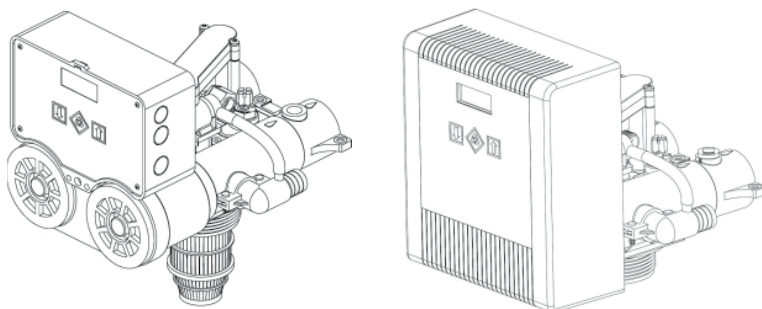

Exploded view of the SFE controller on the V132 valve

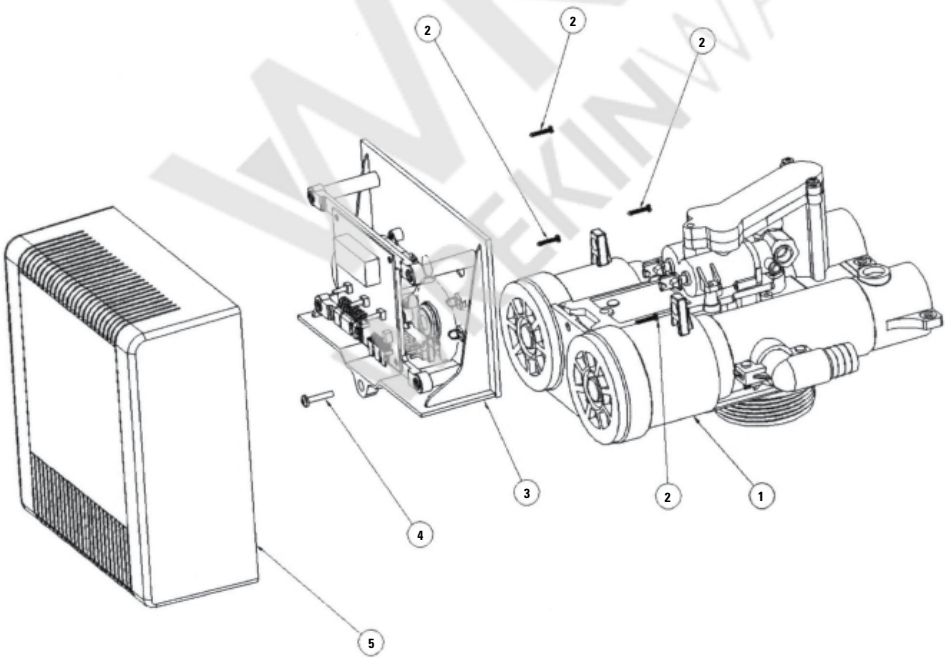

Key:

- 1 Valve v132
- 2 Self-threading screw din 7981c st 2.9x16 (code 101)
- 3 Support with electronic board and cam for twin pilot
- 4 Self-scraping screw din 7981c st 2.9x25 (code 104)
- 5 Cover timer (code 81-pb2)

7.2 Installation on valve V250

The bracket needed is delivered with the valve.

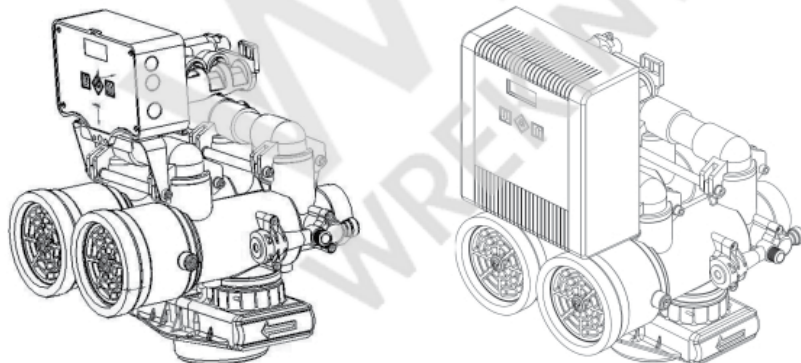

Exploded view of the SFE controller on the V250 valve

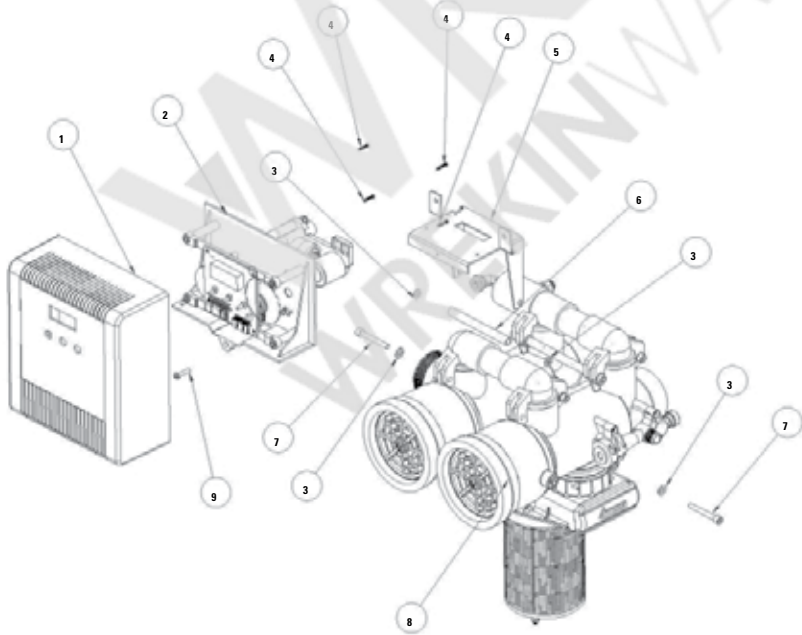

Key:

- 1 Cover timer (code 81-pb2)
- 2 Support with electronic board and external pilots
- 3 Flat washer iso 7089 6.4x12 th. 1.6 (code 5182-r)
- 4 Self-threading screw din 7981c st 2.9x16 (code 101)
- 5 Controller support bracket (code 5191-p)
- 6 Spacer (code 5163-3a)
- 7 Screw tcei uni 5931 m6x45 (code 5183-45)
- 8 Valve V250
- 9 Self-scraping screw din 7981c st 2.9x25 (code 104)

TWIN PILOT SFE TIMER SPARE PARTS LIST

Controller SFE twin pilots

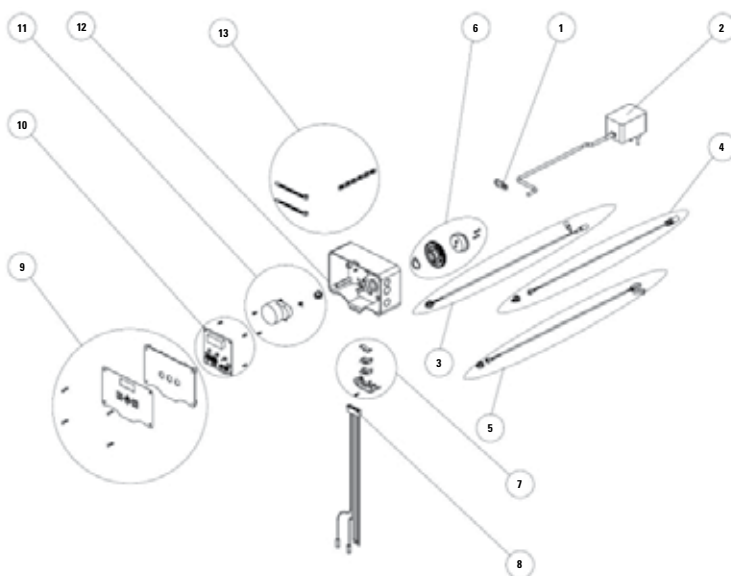

ITEM NO.	PART NO.	DESCRIZIONE	DESCRIPTION
1	90	Blocca cavo	Cord lock
2	95-STD1	Trasformatore 230/12 vac	230/12 ac power supply
	95-ST1	Trasformatore 230/12/12	230/12/12 ac power supply for solenoid
	95-STC1	Trasformatore 230/12/6	230/12/6 ac power supply for chloro
3	K-10020	Kit cavo cella cloro	Chloride cell cable kit
4	K-10018	Kit cavo sensore volumetrico	Meter cable kit
5	K-10019	Kit cavo elettrovalvola	Electrovalve cable kit
6	2229/05	Kit camma	Cam kit
7	88-L2/05	Kit microswitch con supporto	Microswitch and housing kit
8	40695	Kit cablaggio interno	Internal harness kit
9	856-SFE-K1	Kit supporto controller e mascherina	Controller plate and label kit
10	K-7930-03	Scheda elettronica sfe	SFE electronic card
	K-7930-02	Scheda elettronica sfe cloro	SFE electronic card - chloride
11	94-R7K/05	Kit ac motor 1 rpm	Kit ac motor 1 rpm
12	81	Box standard	Box standard
13	K-10017	Kit accessori cablaggio	Harnesses accessories kit

Controller SFE external pilots

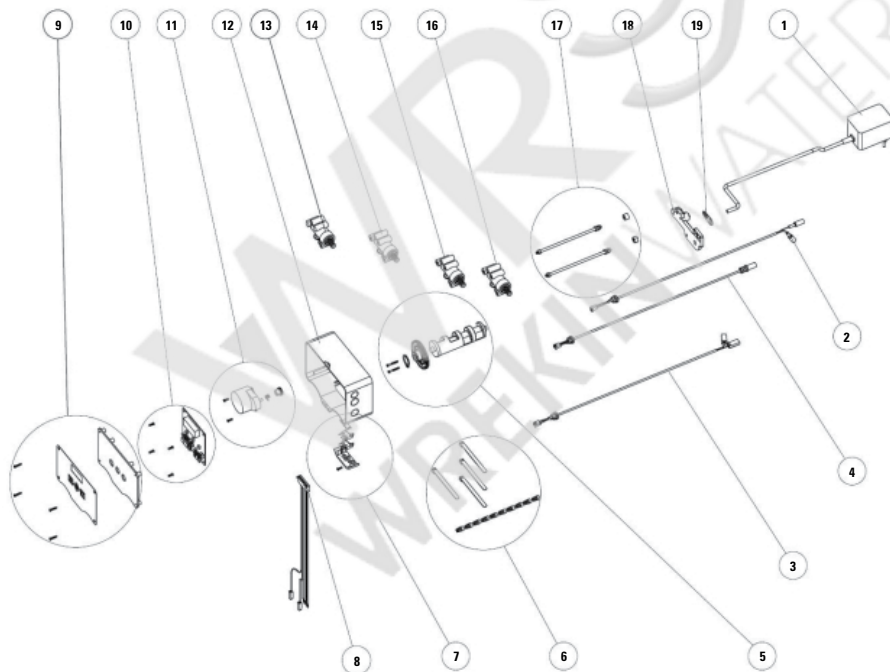

ITEM NO.	PART NO.	DESCRIZIONE	DESCRIPTION
1	95-STD1	Trasformatore 230/12 vac	230/12 ac power supply
	95-ST1	Trasformatore 230/12/12	230/12/12 ac power supply for solenoid
	95-STC1	Trasformatore 230/12/6	230/12/6 ac power supply for chore
2	K-10020	Kit cavo cella cloro	chloride cell cable kit
3	K-10019	Kit cavo elettrovalvola	Electrovalve cable kit
4	K-10018	Kit cavo sensore volumetrico	Meter cable kit
5	2221-*/05	Kit camma esterna	External cam kit
6	K-10017	Kit accessori cablaggio	Harnesses accessories kit
7	88-L2/05	Kit microswitch con supporto	Microswitch and housing kit
8	40695	Kit cablaggio interno	Internal harness kit
9	856-SFE-K1	Kit supporto controller e mascherina	Controller plate and label kit
10	K-7930-03	Scheda elettronica sfe	SFE electronic card
	K-7930-02	Scheda elettronica sfe cloro	SFE electronic card - chloride
11	94-R7K/05	Kit motore 12 vac, 1 rpm	12 vac motor, 1 rpm kit
12	81	Box standard	Box standard
13	2253-BM/05	Kit pilota chiuso	Blind driver kit
14, 15, 16	2253-AM/05	Kit pilota aperto	Open driver kit
17	K-10029	Kit connettore esterno (controller /08, /09, c/07)	External connector kit (/08, /09, c/07 controller)
18	468*-K1	Kit tiranti	Connecting rod kit
19	433-KBM/05	Kit spalla sostegno piloti	Drivers backplate kit
20	90	Blocca cavo	Cord lock

Controller SFE LPlate twin pilots

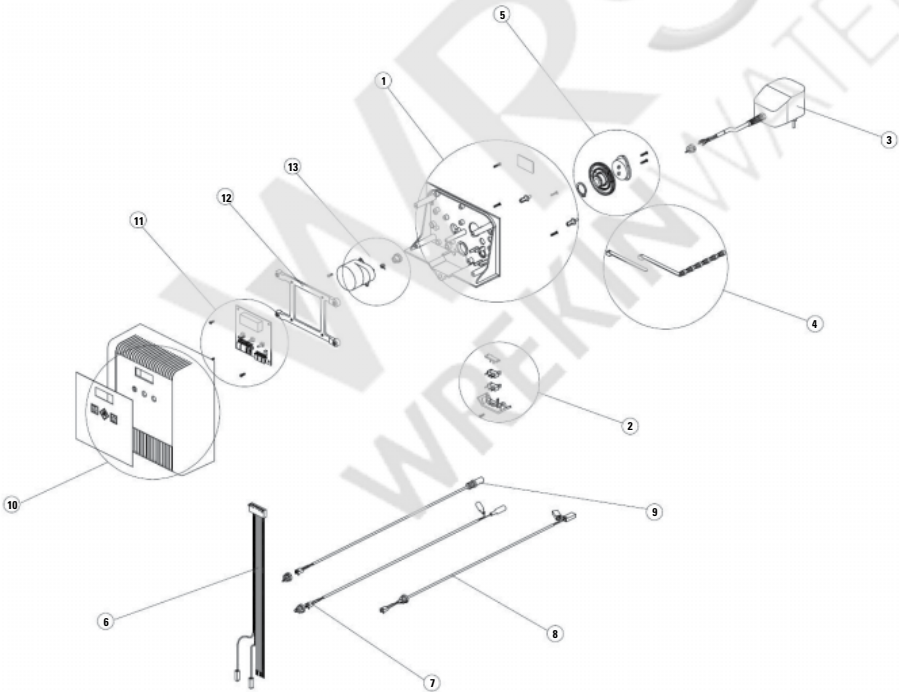

ITEM NO.	PART NO.	DESCRIZIONE	DESCRIPTION
1	81-PLBK1	Kit supporto controller	Controller backplate kit
2	88-L2/05	Kit microswitch con supporto	Microswitch and housing kit
3	95-STD1	Trasformatore 230/12 vac	230/12 ac power supply
	95-ST1	Trasformatore 230/12/12	230/12/12 ac power supply
	95-STC1	Trasformatore 230/12/6	230/12/6 ac power supply
4	K-10017	Kit accessori cablaggio	Harnesses accessories kit
5	2229/05	Kit camma	Cam kit
6	40695	Kit cablaggio interno	Internal harness kit
7	K-10020	Kit cavo cella cloro	Chloride cell cable kit
8	40695-1	Cablaggio interno elettrovalvola	Solenoid valve internal harness
9	K-10019	Kit cavo elettrovalvola	Electrovalve cable kit
10	K-10018	Kit cavo sensore volumetrico	Meter cable kit
11	81-PB2-K1	Kit carter controller	SFE carter kit
12	K-7930-03	Scheda elettronica sfe	SFE electronic card
	K-7930-02	Scheda elettronica sfe cloro	SFE electronic card - chloride
13	81-APL	Telaio supporto scheda sfe	SFE support frame
14	94-R7K/05	Kit motore 12 vac, 1 rpm	12 vac motor, 1 rpm kit
15	K-10029	Kit connettore esterno	external connector kit

(*).The code of the cam kit 2221-* depends on the type of cam used. Refer to customer care service for the right code.

Some code examples are in table A.

(**):The code of kit 468*-K1 depends of the type of cam used.
Refer to table A.

A: Cam spare kit codes

N. PILOTS	TYPE OF CAM	CAM KIT CODE*	CODE KIT 468X-K1**
2	425-22201	2221-2201	4682-K1
	425-222xx (customised)	2221-22XX	
3	425-33301	2221-3301	4683-K1
	425-333xx (customised)	2221-33XX	
4	425-44401	2221-4401	4684-K1
	425-444xx (customised)	2221-44XX	
5	425-55501	2221-5501	4685-K1
	425-555xx (customised)	2221-55XX	
6	425-66601	2221-6601	4686-K1
	425-666xx (customised)	2221-66XX	
7	425-77701	2221-7701	4687-K1
	425-777xx (customised)	2221-77XX	

SPARES KIT	SPARE KIT CONTENTS	
	CODE	QTY
81-PLBK1	81-PLB	1
	101	4
K1-90-XP	90-XP	5
K-10017	BR40422	10
	21759	5
K-92-F	92-F	2
	2	
94-R7K/05	94-SR7	1
	89	1
	118	2
	114-DX	1
K-7930-03	7930-03	1
	118	4
K-7930-04	7930-04	1
	118	4
81-PB2-K1	81-PB2	1
	862-SFE	1
K-88-A	88-A	5
468X-K1**	468-X**	2
	468-R	2
	468-D	4
	468-D3	2
2221-XXXX*	120	2
	119-L/05	1
	84-SEG2/05	1
	425-XXXXX	1
2229/05	84-SEG2/05	1
	84-L/05	1
	101	6
	119-L/05	1

ELECTRICAL CONNECTION DIAGRAM 7930-03

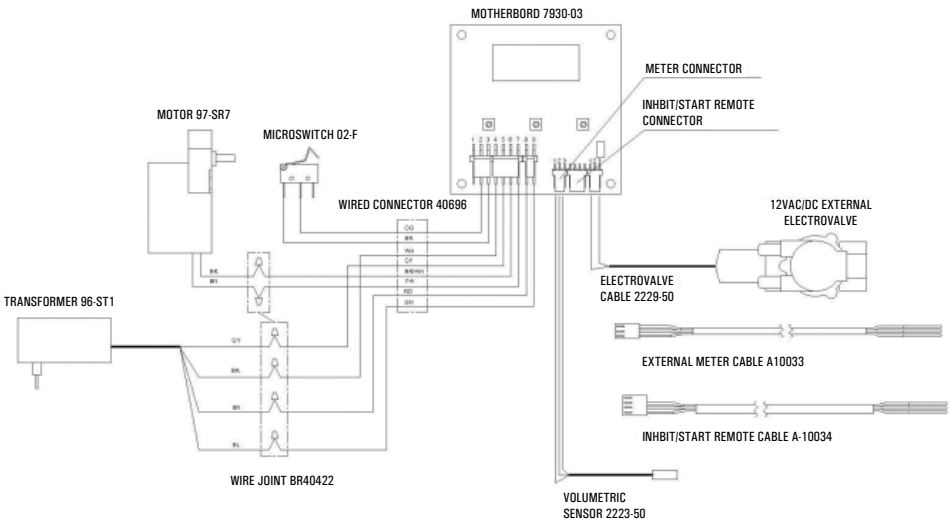

ELECTRICAL CONNECTION DIAGRAM 7930-04

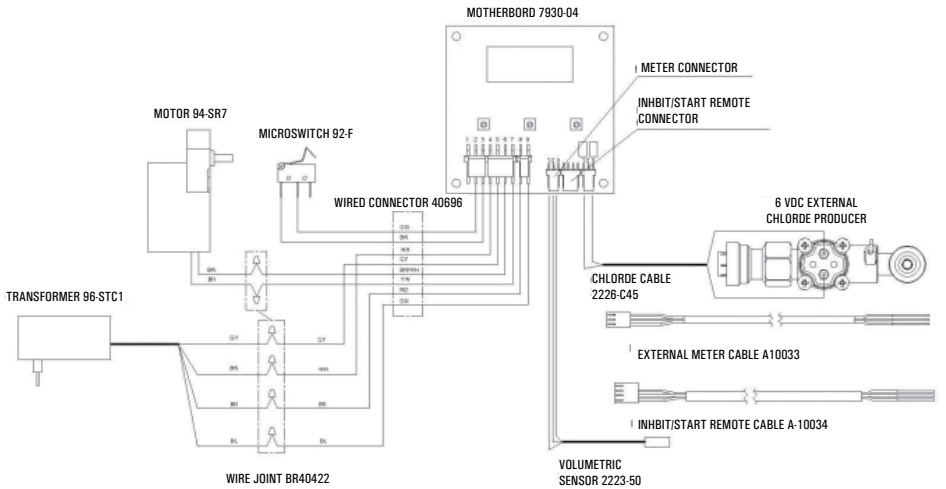

Electrical connection diagram – SFE with SIATA meter or generic magnetic meter

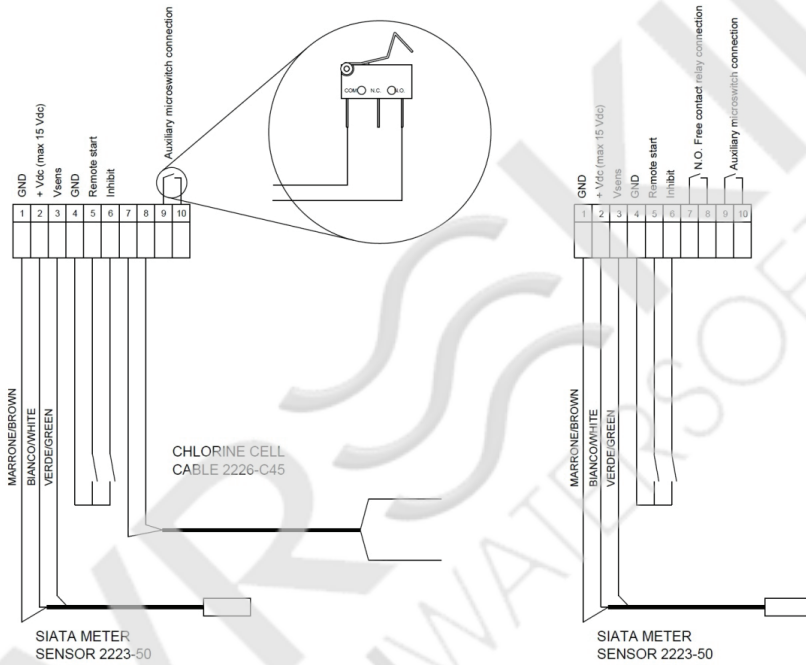

Electrical connection diagram - SFE with reed sensor meter

